

TTP TWIST-TIE

INK JET PRINTERS

INSTALLATION AND OPERATION MANUAL

digital design inc.

**67 Sand Park Road
Cedar Grove, NJ 07009
(973)857-9500**

www.twisttieprinters.com

This manual is for use in operating and maintaining the TTP Ink Jet Printer. This includes various application specific models. For basic start-up instructions, please refer PART 1 Installation Procedures.

All rights reserved. No part of this document may be reproduced, stored on a retrieval system, or transmitted in any form, or by any means electronic, mechanical, photocopying, recording or otherwise, without the prior permission of Digital Design Inc. Digital Design Inc. has a policy of continual product improvement. The Company therefore reserves the right to modify the information contained in this manual without prior notice.

TTP MSDS FOR INKJET CARTRIDGES

4052 BLACK (RED GREEN BLUE) - FOR POROUS SURFACES

This ink is made expressly for use with Inkjet printers manufactured by DIGITAL DESIGN INC. For best results, please follow the instructions contained in the manual provided with the printer.

HEALTH	1
FLAMMABILITY	1
REACTIVITY	0
PERSONAL PROTECTION	B

Reorder Part No. 4052BK or 4052RD or 4052GR or 4052BL

Manufactured by:

DIGITAL DESIGN INC

67 Sand Park Road

Cedar Grove, NJ 07009

RISK PHRASE(S)

Large doses irritating to eyes and respiratory system. Ingestion may cause acute gastro-intestinal upset.

PRECAUTIONARY MEASURES

Wear safety glasses. Use solvent-resistant gloves and vapor respirator for spills, leaks or other high exposures.

FIRST AID MEASURES

INHALATION: REMOVE TO FRESH AIR.

EYE CONTACT: CONTACT WITH THE EYES MAY CAUSE MILD IRRITATION. IMMEDIATELY FLUSH WITH LARGE AMOUNTS OF CLEAN, LUKEWARM WATER (LOW PRESSURE) FOR AT LEAST 15 MINUTES. SEEK MEDICAL ATTENTION IF EYE IRRITATION PERSISTS.

SKIN CONTACT: WASH AFFECTED AREAS THOROUGHLY WITH SOAP AND WATER. CLOTHING SHOULD BE LAUNDERED BEFORE REUSE. SEEK MEDICAL ATTENTION IF SKIN IRRITATION PERSISTS.

INGESTION: INGESTION OF INK MAY CAUSE STOMACH UPSET. SEEK MEDICAL ADVICE. SEEK MEDICAL ATTENTION IF STOMACH UPSET PERSISTS (THIS INK CONTAINS ETHYLENE GLYCOL).

Guarantee Exclusion and Limitation of Liability: For a period of one year from the date of manufacture, DIGITAL DESIGN INC. ("Seller") warrants that the ink shipped shall conform to Seller's specifications. EXCEPT FOR THIS WARRANTY, SELLER MAKES NO WARRANTY OF ANY KIND, INCLUDING THE WARRANTY OF MERCHANTABILITY, OR FITNESS FOR A PARTICULAR PURPOSE. On any claim accepted by the Seller, SELLER'S LIABILITY SHALL NOT EXCEED ITS OBLIGATION TO REPLACE THE ALLEGEDLY DEFECTIVE INK, OR TO RETURN THE PURCHASE PRICE PAID BY THE PURCHASER FOR ALLEGEDLY DEFECTIVE INK. IN NO EVENT SHALL SELLER BE LIABLE FOR ANY CONSEQUENTIAL, INCIDENTAL OR SPECIFIC DAMAGES, WHETHER IN TORT OR CONTRACT OR ANY THEORY OF LAW.

TWIST-TIE PRINTER (TTP) CONTROLLER

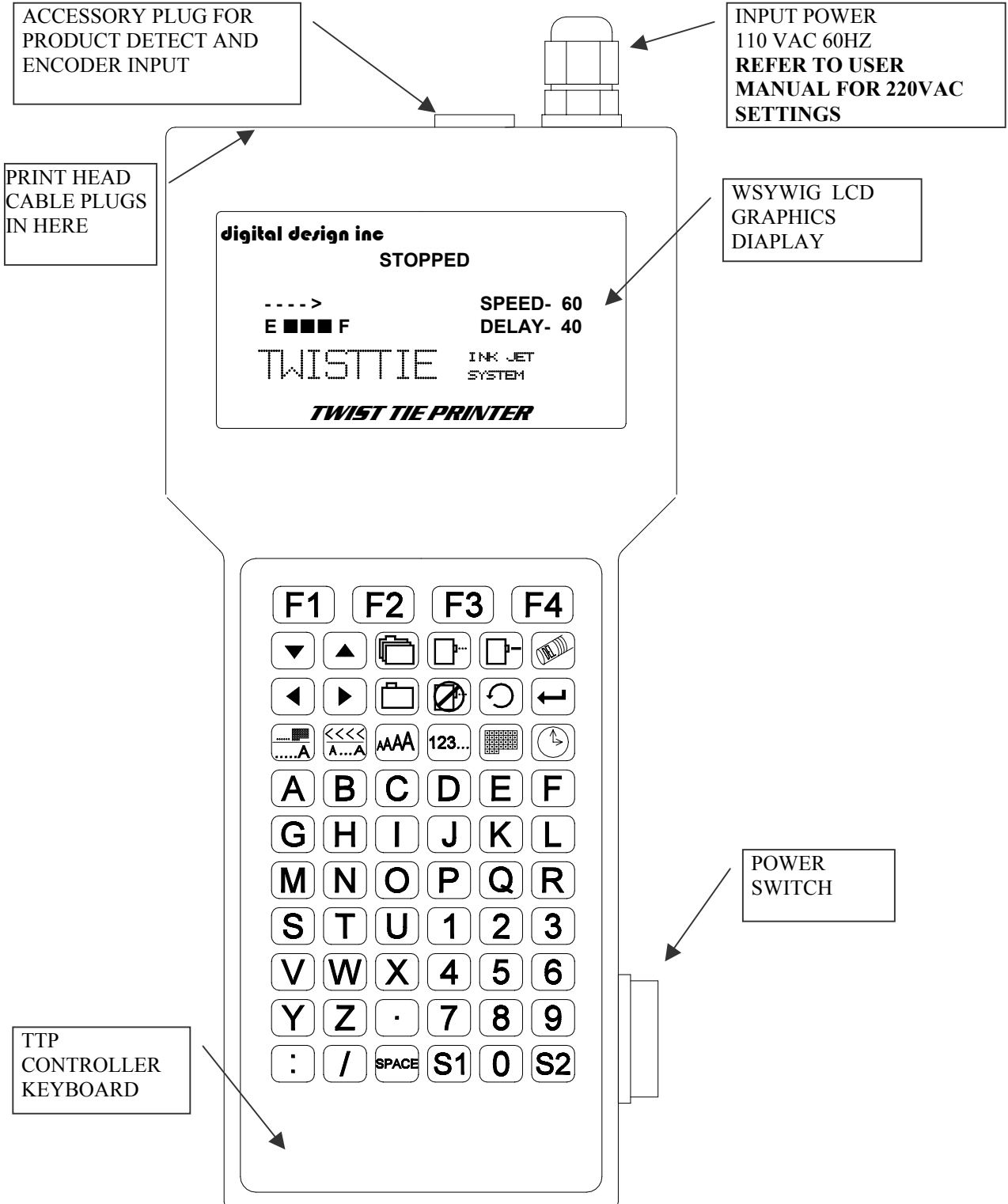

TTP TWIST-TIE INK JET PRINTING SYSTEM

INSTALLATION AND OPERATION MANUAL

TABLE OF CONTENTS

PART 1 Installation Procedures	1-1
PART 2 Operation Procedures	2-1
PART 3 Maintenance Procedures	3-1
PART 4 Troubleshooting and Repairs	4-1
PART 5 Parts List	5-1

AMENDMENT RECORD

Amendment

All Pages at First Issue

Date

19 SEPT 2003

PART 1: INSTALLATION PROCEDURES

CONTENTS

INSTALLING THE TTP PRINTING SYSTEM	1-2
PLAS-TIES Model 603 and 604	1-3
THREADING THE TTP PRINT CARRIAGE	1-11
INPUT POWER CONNECTION AND MODIFICATION	1-12
INSTALLING THE PRINT CARTRIDGE	1-13
CONNECTING THE TTP CONTROLLER TO THE CARRIAGE	1-14
CONFIGURING THE TTP PRINTING SYSTEM	1-15
TTP QUICK START	1-16
Creating a Message	1-17
Saving and Loading a Message	1-18
Special Fields in a Message	1-19
TTP SYSTEM QUICK SETUP	1-20

INSTALLING THE TTP PRINTING SYSTEM

Determine the correct manufacturer and model number for your current equipment. Manufacturers model numbers are affixed to a label located at the rear of the machines. If you have any questions as to the correct make and model of your equipment, contact your local equipment supplier.

Caution should be taken while installing the TTP printing system on your equipment. Digital Design Inc. has taken every precaution to ensure a safe and accurate instruction set to guide the installer through the installation process.

Follow the operational guidelines in the correct installation procedures.

The TTP Printing System is shipped from the factory configured specifically for the twist tie machinery requested. If it is necessary to re-configure the TTP Printing System for a different twist tie machine follow the procedure on SYSTEM RESET TO FACTORY DEFAULT SETTINGS.

- VERIFY THAT YOUR EQUIPMENT IS IN PROPER OPERATING CONDITION**

- LOCATE THE CORRECT MAKE AND MODEL OF YOUR EQUIPMENT**

- FIND THE PROPER INSTALLATION INSTRUCTIONS FROM THE FOLLOWING INSTALLATION PROCEDURES**

- READ CAREFULLY ALL INSTALLATION PROCEDURES BEFORE PROCEEDING**

- INSTALL THE TTP PRINTING SYSTEM ON YOUR EQUIPMENT. THERE IS NO EXTRA HARDWARE REQUIRED OTHER THEN THAT SUPPLIED IN THE INSTALLATION KIT. THERE ARE NO EXTRA HOLES TO BE DRILLED. DO NOT DISCARD ANY SCREWS REMOVED IN THE INSTALLATION PROCESS; THEY WILL BE USED FOR THE INSTALLATION.**

INSTALLATION FOR PLAS-TIES MODEL 603 AND 604

To install the printer, first remove and retain the two screws and washers that hold the Brake Arm Assembly in place. Using the two screws supplied in the installation kit, attach the Extension Arm Assembly (C20821) to the two holes in the Brake Arm Assembly. Attach the Brake Arm Assembly to the twist tie machine base using the two existing hardware.

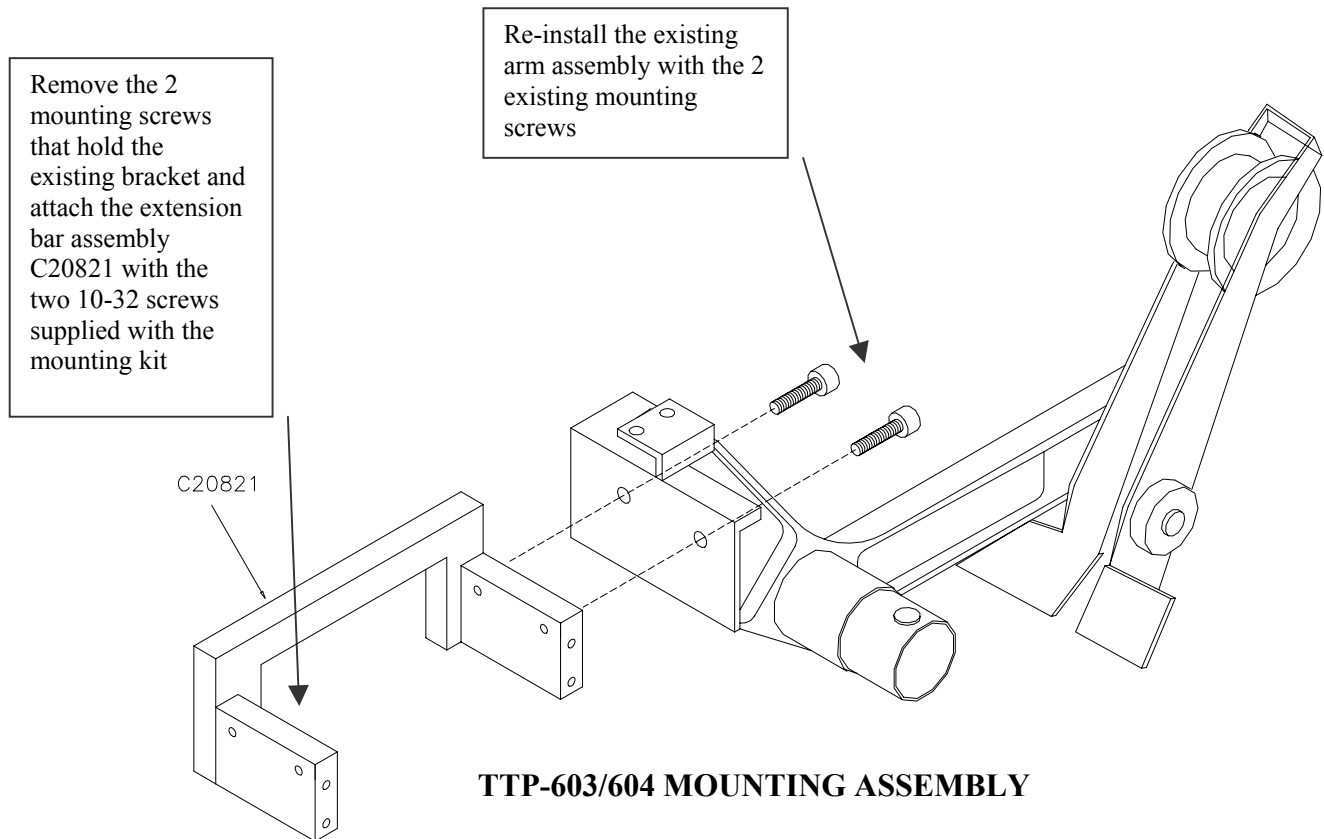

Install the print head as shown in the diagram below. Note the orientation and tighten the two knurled knobs to fasten the print head to the extension bar.

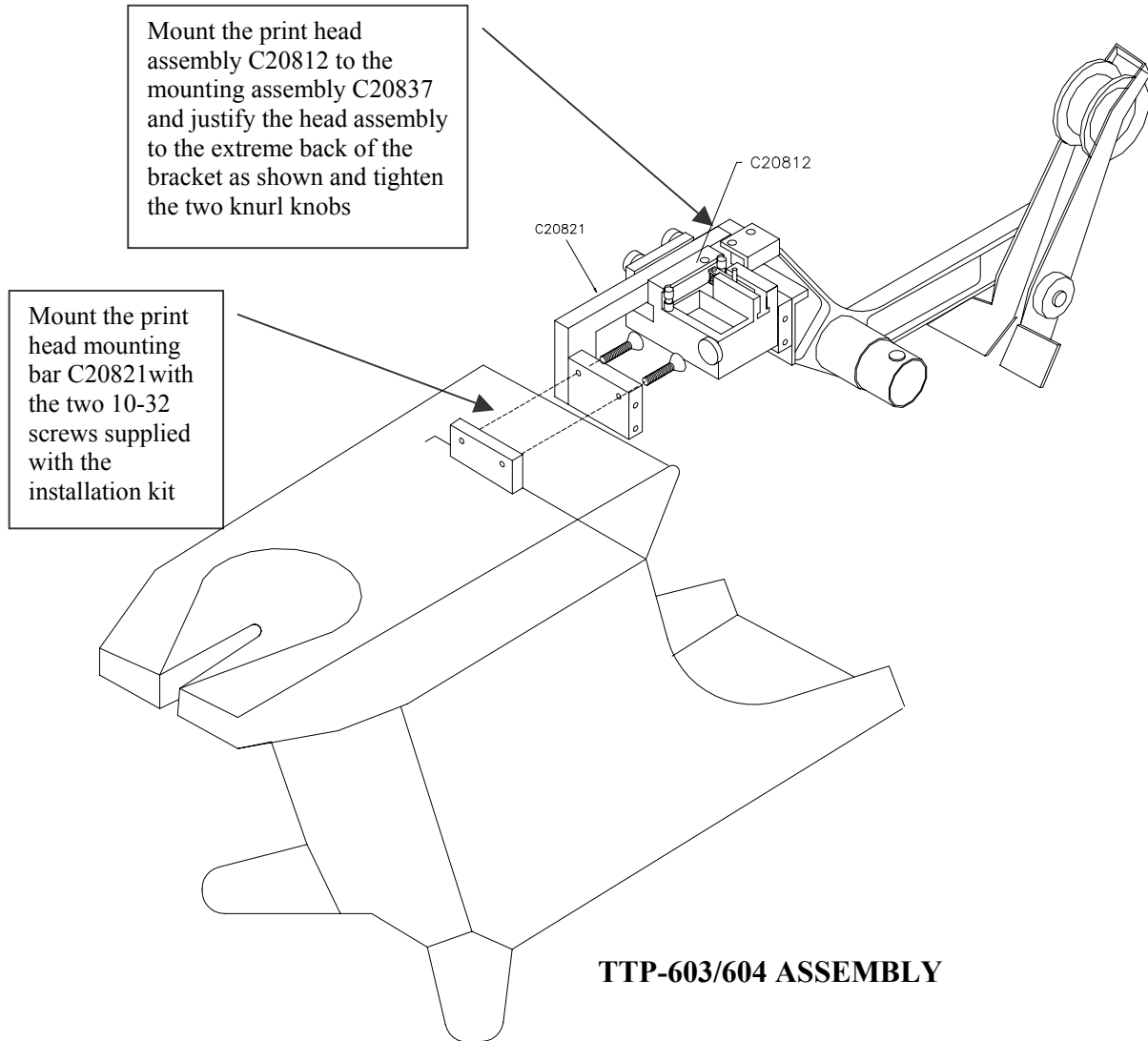

THREADING THE TTP PRINT CARRIAGE

The TTP print carriage is threaded the same for all TTP models. During the threading process make sure that the twist tie material has the paper side facing toward the ink cartridge. The inks used are intended for a porous material and **WILL NOT ADHERE TO THE PLASTIC SIDE OF TWIST TIE MATERIAL.**

To thread the TTP print carriage C20812 insert the end of the twist tie material between the notch in the TAPE GUIDE (**paper side faces as shown**). Pull back on the PRESSURE ARM in the direction depicted by the arrow and continue to completely pass the twist tie material through the carriage assembly. Continue to pull the twist tie material and insert into the twist tie machine per manufacturer recommendations.

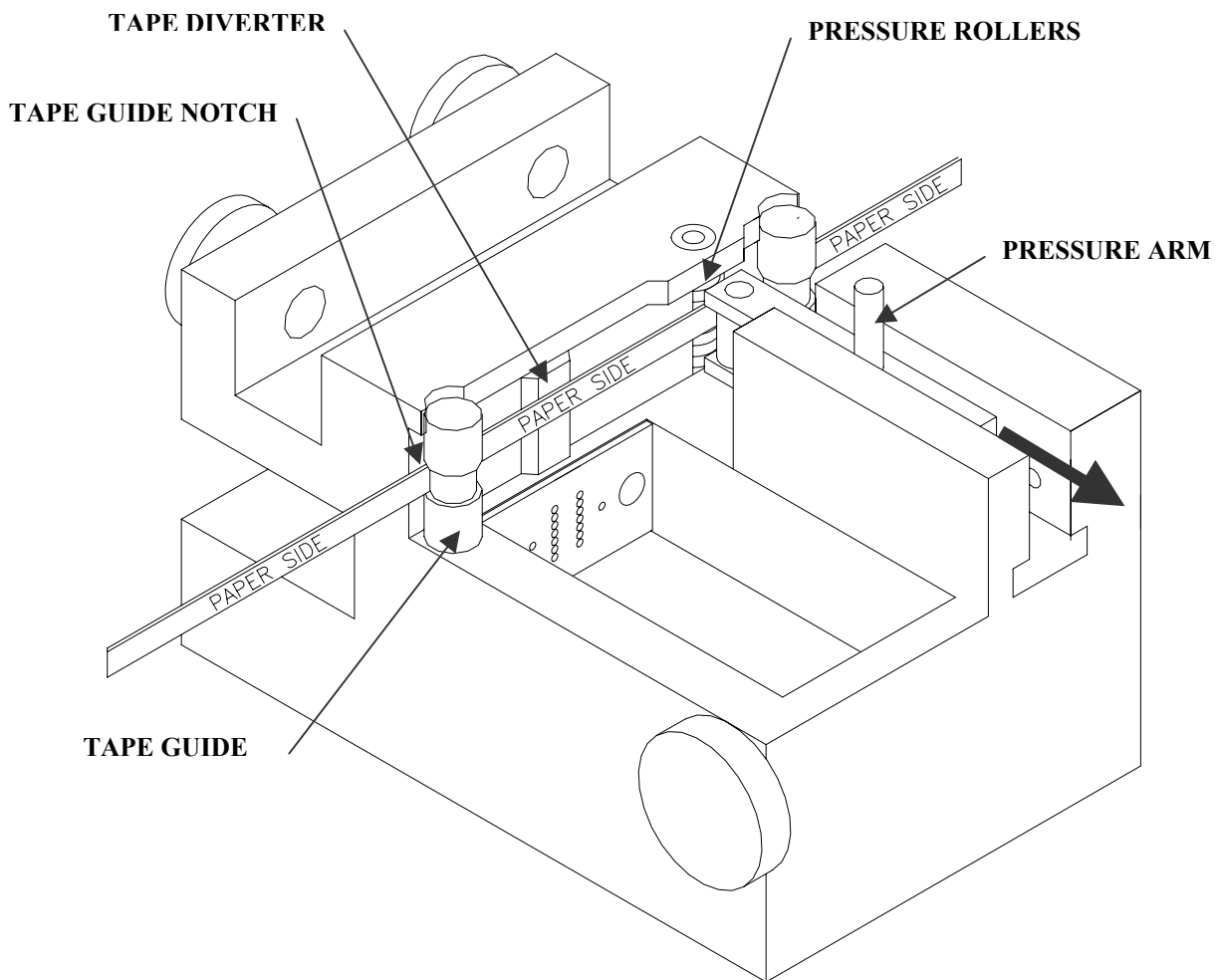

THREADING THE C20812 PRINT CARRIAGE

INPUT POWER CONNECTION AND MODIFICATION

Insert the power connector to the appropriate power source. The factory setting is 110 VAC 60Hz.

NOTE: MODIFICATION OF THE UNIT TO THE ALTERNATE 220 VAC 60HZ SHOULD BE ATTEMPTED BY TRAINED PERSONNEL ONLY.

- ✓ Unplug the unit from the power source
- ✓ Carefully remove the 8 screws from the rear of the TTP controller cabinet
- ✓ Remove the top of the cabinet
- ✓ Locate the jumper JP4 (pictured below)
- ✓ Remove the jumpers on JP4 from the factory default 1-2 and 3-4 (110VAC)
- ✓ Install only a single jumper on JP4 from 2-3 (220 VAC)
- ✓ Store the extra jumper in a safe place for future modifications

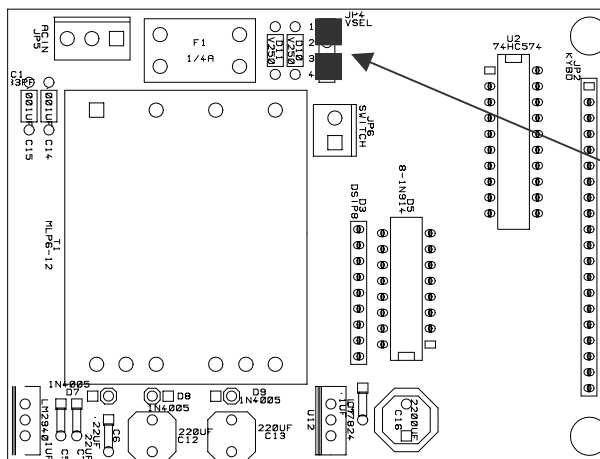

JUMPER PINS
1-2
AND
3-4

Power
settings for
110 VAC 60
Hz

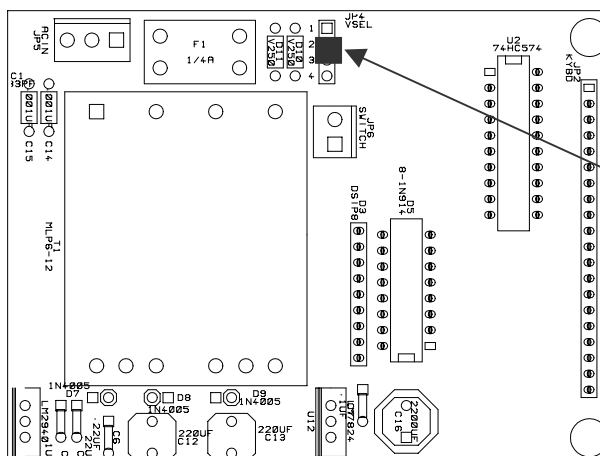

JUMPER PINS
2-3

Power
settings for
220 VAC 60
Hz

INSTALLING THE INK CARTRIDGE

Remove the protective film from the face of the print head and save the film to cover the print head during long periods of shut down. Turn the Print Head Release knob clockwise so that the locking half shaft is vertical (it will stop into position) as shown in Step 1. Lower the print head into the pocket with the tab slightly elevated and the locating pins pointing down as shown in Step 2. When the Print Head is against the bottom of the pocket push the cartridge forward, be sure that the two locating pins have aligned into the front holes and that the rear locating tab has firmly seated in the slot, as shown in Step 3. Turn the Print Head Release knob counter-clockwise 90° to lock against the ledge on the

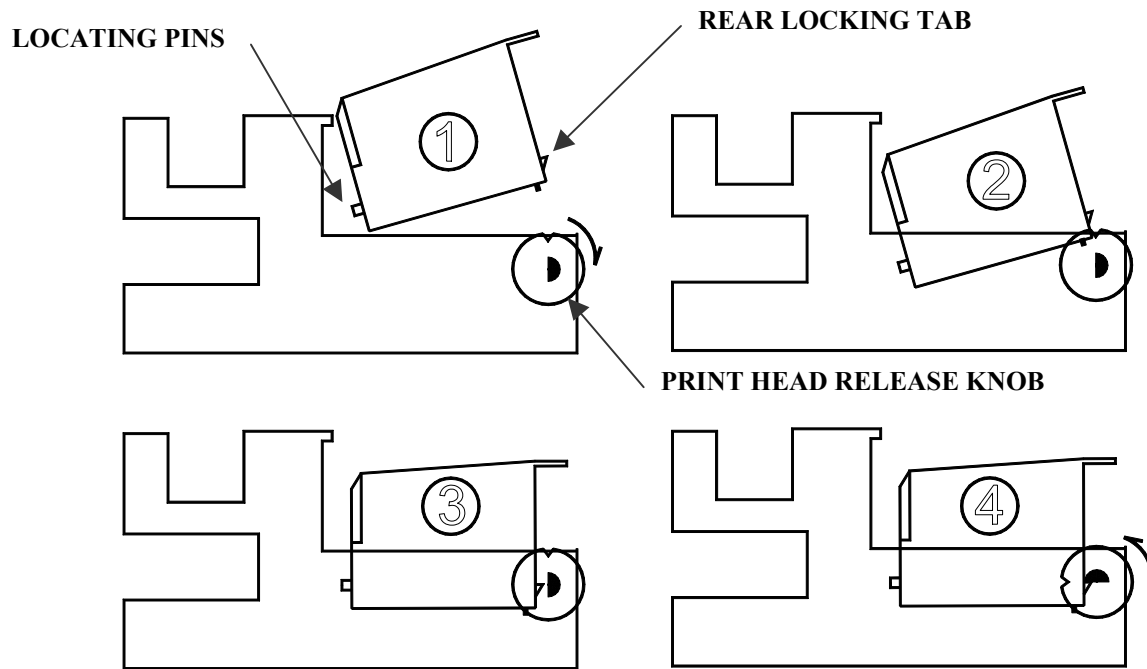

back of the print head.

CONNECTING THE TTP CONTROLLER TO THE TTP CARRIAGE

Before beginning the installation of the connecting cable turn the power switch to the off position.

To Connect the TTP Controller to the TTP print carriage use the interconnect cable C40016-3 supplied with the TTP Printing System. The cable is a 15 conductor female to female configuration that is 3 feet long.

Connect either end of the cable to the TTP Carriage Assembly and tighten the jack screws that secure the cable to the carriage assembly. Connect the other end to the TTP Controller Assembly and secure the connector in place with the jack screws.

CAUTION:

- ❑ **POWER MUST BE TURNED OFF**
- ❑ **NOTE ORIENTATION OF THE CONNECTORS**
- ❑ **DO NOT FORCE CONNECTORS INTO POSITION**
- ❑ **TIGHTEN THE SECURING JACK SCREWS**

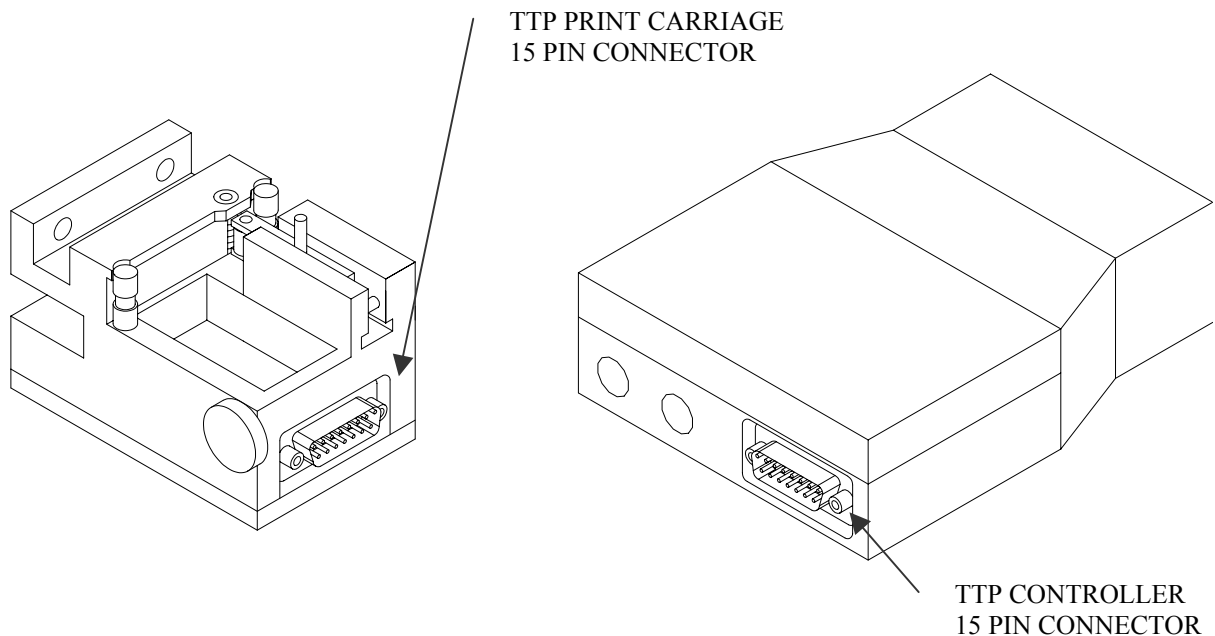

CONFIGURING THE TTP PRINTING SYSTEM

To verify the current operating software press the STOP PRINT  key.

Press the V key

```
PLAS-TIES 603
TY VERSION 1.00
SN # XXXXXXXX

=====

TWISTTIE INK JET
          SYSTEM
```

The top line of the display indicates which model twist tie machinery is the current default settings.

The second line indicates the current TTP operating software version.

The third line of information is the TTP Printing System serial number.



Press any key to return to the STOPPED screen

In the event it is necessary to reset the unit to its default values, turn the controller off. While holding  down, turn the power on.

```
< -- MODEL -- >

TTP-3550

=====
```

The RESET operation will prompt the user to enter the proper model number of the twist tie machine. To access various models use the  or  keys to select the correct model number.

NOTE: THE USER MUST SELECT THE CORRECT MODEL NUMBER AFTER A RESET

```
ERASE ALL
STORED MESSAGES

YES OR NO   Y/N

=====
```

Press the ENTER key  to select the model number shown.

After selecting the correct model the screen to the left appears. The user has the option to ERASE all messages stored in the TTP controller.

CAUTION: PRESSING THE Y KEY WILL DELETE ALL STORED MESSAGES IF MESSAGES ARE TO BE SAVED PRESS N

If the message storage is not deleted the TTP controller will only load all the factory defaults for the selected twist tie machine.

NOTE: If a RESET function is performed as a result of a system lock-up it is recommended that the user does not delete the currently saved messages. Allow the system to reset only the factory defaults. Test the system to determine if the problem has been corrected. In the event the problem is not corrected it may be the fault of an illegal message or possibly corrupted message storage.

TWIST TIE PRINTER QUICK START

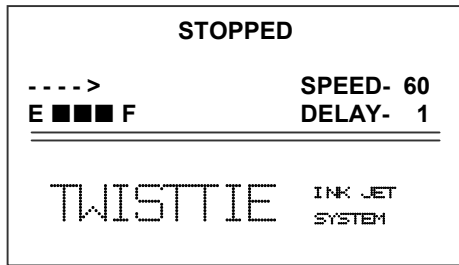





Connect the printer controller to the appropriate power source (110 VAC factory default). **For connection to alternate power sources refer to the user manual.**

Turn the printer controller ON with the power switch located on the right side of the unit.

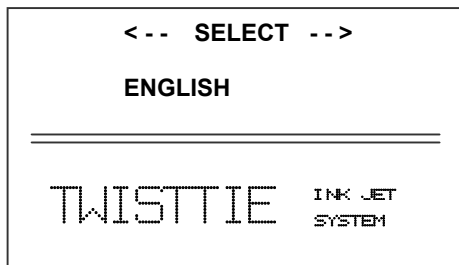
On startup the LCD displayed pictured will be seen.

CHANGING LANGUAGE PROMPTS



Press the F4 key  and select  for LANGUAGE. Use the   keys to select the desired language

ENABLING PRINT MODE

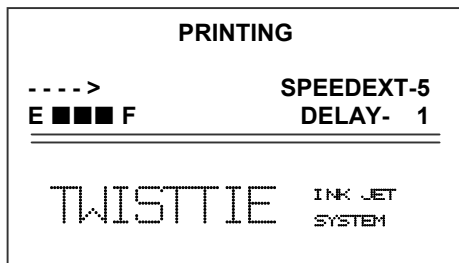

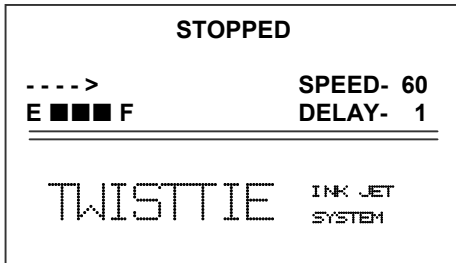

Press the GREEN print enable key  to start printing

ENTERING A MESSAGE





Press the GREEN STOP PRINT key 
The LCD display will change from PRINTING to STOPPED.

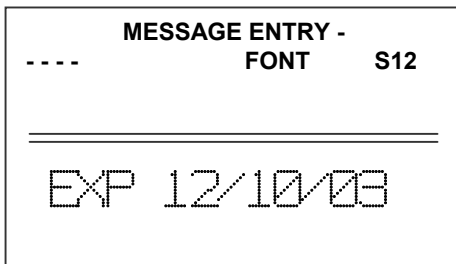

Press the GREEN EDIT key 
Press the BLUE F3 key  to delete the entire message



Press the BLUE FONT key  to select the desired font and enter the text EXP 12/10/03
Press the ENTER key  to end the MESSAGE EDIT mode

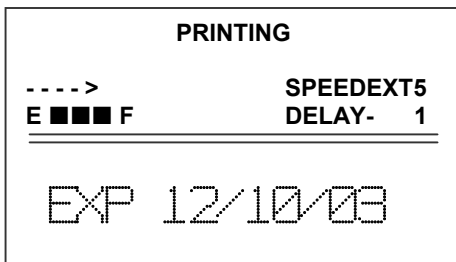

Press the GREEN print enable key  to enter the print mode

SAVING/LOADING A MESSAGE

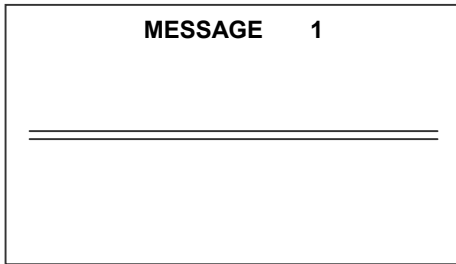

STORING A MESSAGE



Press the GREEN STOP PRINT KEY 

Press the RED MESSAGE STORE key 

The LCD display will display the message storage screen

Use the  or  to select the desired storage location

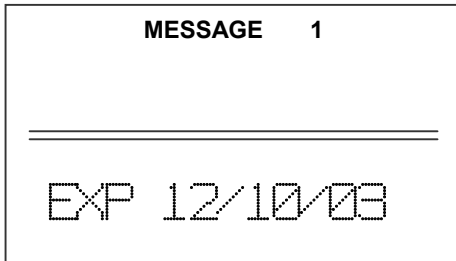



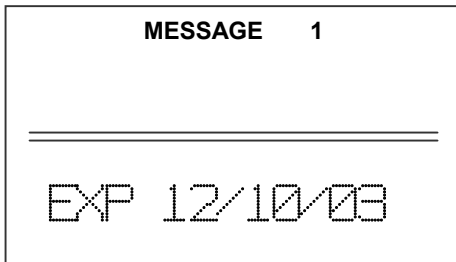

Press the RED MESSAGE STORE KEY  a second time and the current message appears in the selected location

Press the ENTER key  and the message is stored

LOADING A MESSAGE



Press the GREEN STOP PRINT KEY 

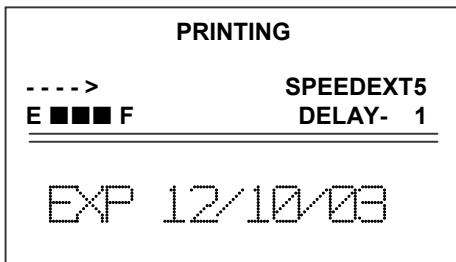

Press the RED MESSAGE STORE key  and use the  or  keys to select the desired message and press the ENTER  key









Press the GREEN print enable key  to enter the print mode



SPECIAL FIELDS IN A MESSAGE

The printer has the capability of inserting special fields in a message. These special keys are only available in the edit mode

Use the DATE key  to insert the currently formatted date in a message. Date format setup may be found by pressing the F3 key  and selecting  for DATE FORMAT
NOTE: REFER TO OPERATORS MANUAL FOR DETAILS

Use the TIME key  to insert the currently formatted time in a message. Time format setup may be found by pressing the F3 key  and selecting  for TIME FORMAT
NOTE: REFER TO OPERATORS MANUAL FOR DETAILS

Use the DATE OFFSET key  (expiration date) to insert an expiration date in a message. Expiration setup may be found by pressing the F4 key  and selecting  for DATE OFFSET
NOTE: REFER TO OPERATORS MANUAL FOR DETAILS

Use the SEQUENCE NUMBER key  to insert a sequence number in a message.
Enter the desired starting sequence number followed by the ENTER key  this returns the operator to the EDIT mode
NOTE: REFER TO OPERATORS MANUAL FOR DETAILS



TTP SYSTEM QUICK SETUP

1. Reset ink level. Press the following keys in order:



2. To set the character width, press  to put the system in the Printing mode. Set character width by



3. Use   to increase or decrease value. Minimum value is 1 and a maximum is 9.
Note: Character Width should be set to provide a satisfactory code on the tail of the twist-tie material
4. To position print on twist tie press: Each increment or decrement changes the delay by one dot column.



You may continue to experiment with character width and delay until the desired code registers on the twist tie is achieved.

PART 2 : OPERATION PROCEDURES

CONTENTS

DESCRIPTION	2-2
Print Station Keypad and LCD	2-2
Keypad Key Descriptions	2-3
Turning on the Print Station for the First Time	2-4
PROGRAMMING	2-5
Definitions	2-5
PRINTING Mode and STOPPED “Command” Mode	2-5
Menu Structure	2-6
F1 Menu	2-7
F2 Menu	2-8
F3 Menu	2-10
F4 Menu	2-14
SETTING UP SYSTEM PARAMETERS	2-16
Setting the Date	2-17
Setting the Time	2-18
SETTING UP OTHER PARAMETERS	2-19
Setting Character Width	2-19
Setting Print Delay	2-20
INPUT, EDIT AND DELETE MESSAGES	2-21
Password Protection	2-23
Editing the Message or Parts of the Message	2-24
Storing a Message	2-25
Recalling A Stored Message	2-25

DESCRIPTION PRINT STATION KEYPAD AND LCD

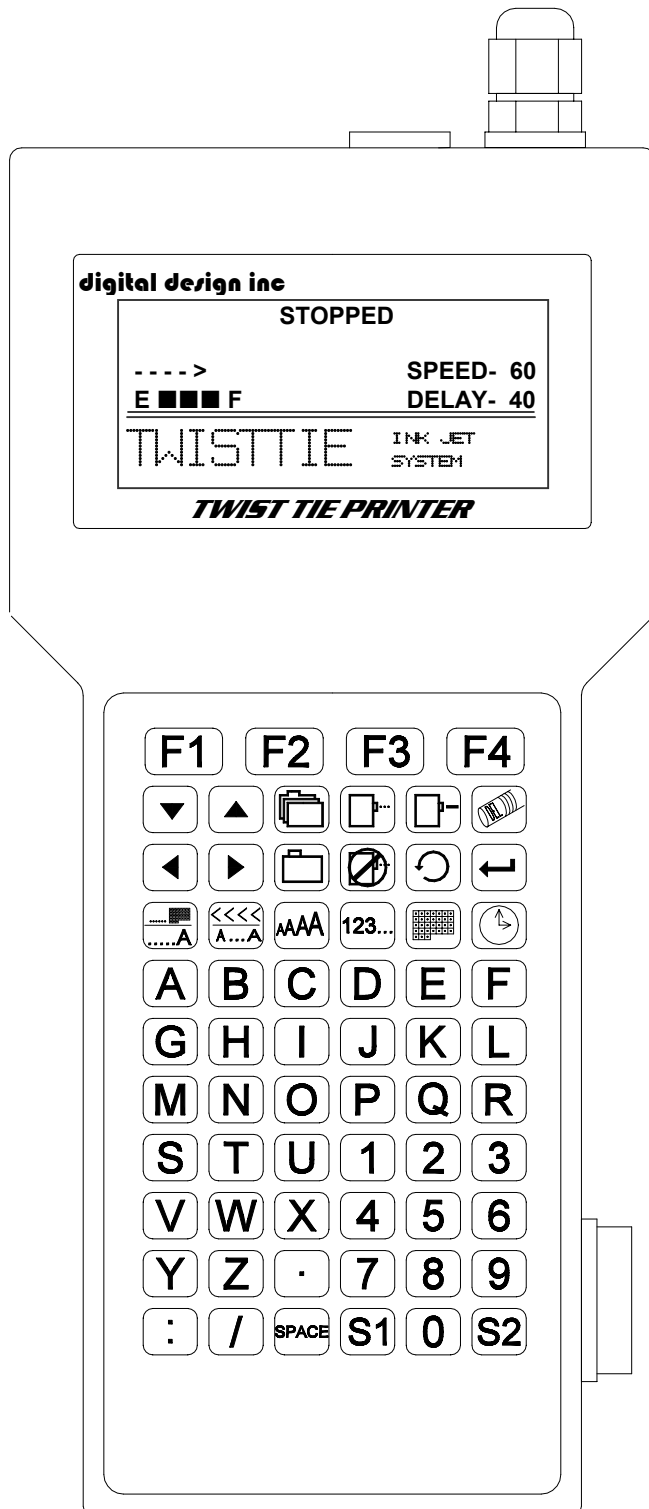

The keypad on the print station, pictured here, contains 64 keys. The LCD will display various messages to assist in programming on the upper half of the display. The lower half of the display will show the entered print message.





















The system operates in 3 basic modes. They are: Print Mode, Command Mode, and Message Entry Mode. In Print Mode the majority of the keys on the keypad are disabled to avoid inadvertent changes. When in Print Mode the Top line of the LCD will display **PRINTING**

The Command Mode is used to change the functions of the printer. When in the Command Mode the display will show **STOPPED** on the top line. The Message Entry Mode is used to create or modify printable codes, when in this mode the top line of the display will show **MESSAGE ENTRY**.

The 4 keys on the top row are the function keys F1 through F4. They each consist of submenus for modifying various printer functions. Their specific menus are detailed later in this section. The next two rows of keys with icon legends directly control

specific parameters of the printer as outlined on the following page.

KEYPAD KEY DESCRIPTIONS

	This is the manual cycle key. When in the Command mode, pressing this key causes the printer to print one code. Printing occurs when the key is released
	This is the Print key. Use it to place the unit in the Print mode
	This is the Stop Print key. Use it to stop printing and place the unit in the Command mode.
	This is the Purge key. Use it to purge ink for maintenance purposes. The unit must be in the Command mode to use this key.
	Use this arrow to decrease values, and use it to move the cursor in the message line while editing the message.
	Use this arrow to increase values and use it to move the cursor in the message line while editing the message.
	Use this arrow to move the cursor between the message lines while in Edit mode and building a message.
	Use this arrow to move the cursor between the message lines while in Edit mode and building a message.
	This key is the Message Storage key. Use it to store and to recall individual codes.
	This is the Delete key. Use it to backspace to delete a character when mistyped as well as to exit from certain menus.
	This is the Message Entry key. Use this key to enter the Message Entry mode, to input a code or to edit a code.
	This is the Enter or Return key. When pressed, the unit will accept input and exit certain menus.
	This is a dual function key. In Command or Printing mode, this is the Print Delay key. In Message Entry mode, this is the Date Offset key.
	This is a dual function key. In Command or Printing mode, this is the Line Speed key. In Message Entry mode, this is the Shift Code key.
	This key selects the Font size. One of several fonts are selectable. Use this key when creating a message in Message Entry mode to choose a font.
	This key places a Sequential Number in a message when in the Message Entry mode.
	This is the Date key. When in Message Entry Mode this key will insert the current calendar date into the message. In Command Mode this key allows modification of the calendar date.
	This is the Time key. When in Message Entry Mode this key will insert the current time into the message. In Command Mode this key allows modification of the actual time.
	Pressing this key while in the Message Entry mode accesses these special characters: ! " # \$ % & ■ () * + , — £ < = > Á ç Ä ö ü ñ É ó
	This key is reserved for special customer requested characters

The remaining keys are used to produce messages including the space key, the period key, slash and the colon keys.

TURNING ON THE PRINT STATION FOR THE FIRST TIME

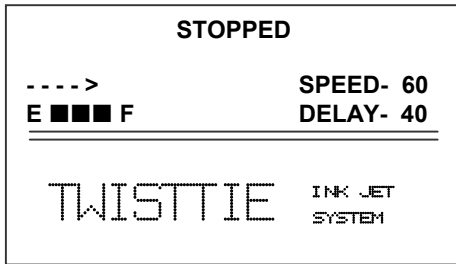

To turn the print station on and off, depress the power switch UP for on and DOWN for off.

The first time the print station is turned on, as received from the factory, the LCD will look like the illustration on the left. Each line gives important information regarding the system:

The Top line indicates the operating mode of the unit: “STOPPED” when in Command mode, “ PRINTING” when in Print mode, and “MESSAGE ENTRY when in message entry.

The 2nd line shows the direction of travel for the product and the programmed SPEED (in the STOPPED mode or SPEEDEXT (character width setting) in the PRINTING mode .

The 3rd line shows the status of the ink supply, Empty to Full on the left of the display, and the programmed print delay value to the right.

The lower half of the display shows the message entered for printing. This may be single or multiple lines of code

PROGRAMMING

DEFINITIONS

There are two parts to programming the TTP ink jet printer,

- setting the operations parameters, (dot size, character width, delay, date format, time format, etc.) and
- building the message.

PRINT MODE AND STOPPED “COMMAND” MODE

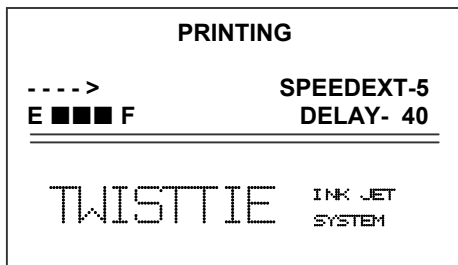

When in the Print mode the screen will look like the screen on the left. When PRINTING is seen on the LCD, the unit will print as TWIST TIE MATERIAL passes thru the TTP head. To enter Print mode, press .

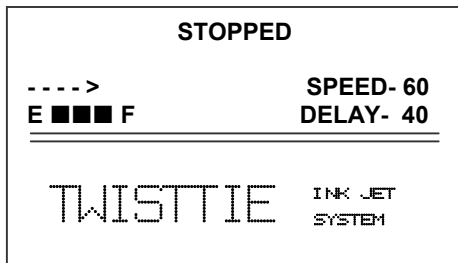

When in the Command Mode the screen looks like the illustration at left. When STOPPED the printer will not print when twist tie material is moved through the TTP print head.

In Command mode, access can be made to the menus under the function keys, **F1** through **F4** icon control keys plus access to Message Entry Mode. To enter Command mode, press .

MENU STRUCTURE

In the Command mode, access is allowed to the menu structure for basic parameters. The menus reside within the function keys, **F1** through **F4** . In order to select one of the parameters, press the number key that corresponds to the desired parameter.

F1

The **F1** key, when pressed, brings up the menu as shown below.

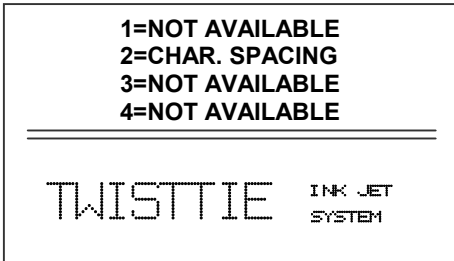

F2

The **F2** key, when pressed, brings up the menu as shown below.

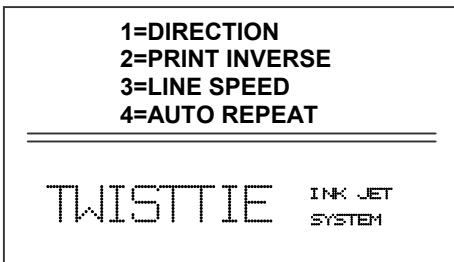

F3

The **F3** key, when pressed, brings up the menu as shown below.

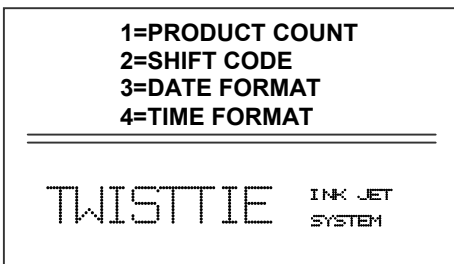

F4

The **F4** key, when pressed, brings up the menu as shown below.

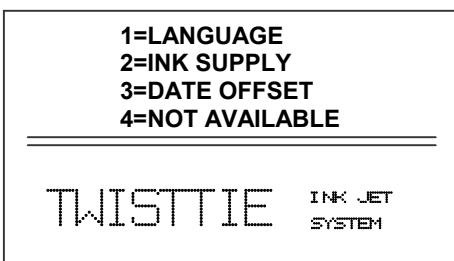

F1 MENU



Place the unit in the Command mode and press **F1**. The screen shown to the left is produced. Press the correct number to make changes to that parameter. Those selections designated as NOT AVAILABLE will not respond to selection. They are reserved for future system expansion.

2 - CHARACTER SPACING:

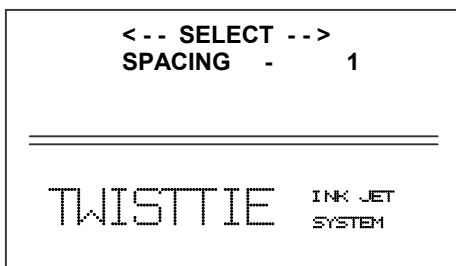

This parameter controls the amount of space between characters in the code. Spacing can be varied from 1 to 6 dots. Use this control to make printed codes more legible when code is compressed. Press the **2** then press **▶** or **◀** to change the value. Press **↩** once the desired value is displayed.

F2 MENU

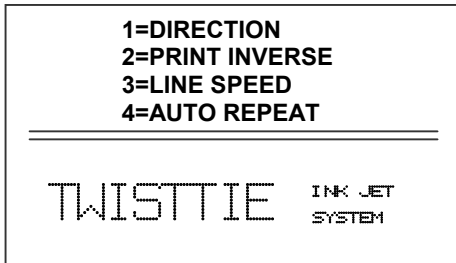

1 - DIRECTION:

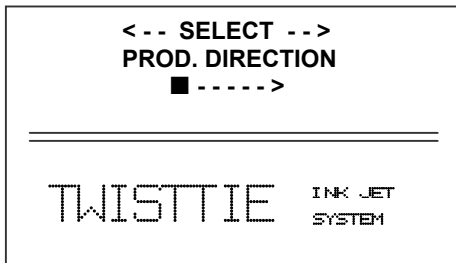

Place the unit in the Command mode and press **F2**. The screen shown to the left is produced. Press the correct number to make changes to that parameter

The arrow shown on the LCD's third line screen should agree with the direction of product travel. Press **▶** or **◀** to change direction. Press **↵** for the unit to accept the change.

2 - PRINT INVERSE:

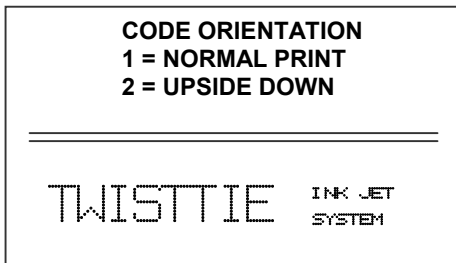

This parameter allows the code to print right side up or upside down. Pressing **2** will produce the following screen. Press **1** for normal print or **2** for upside down codes. Save the choice by pressing **↵**. Look for the change of direction on the imprint.

3 - LINE SPEED:

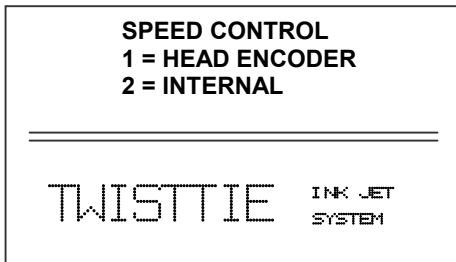

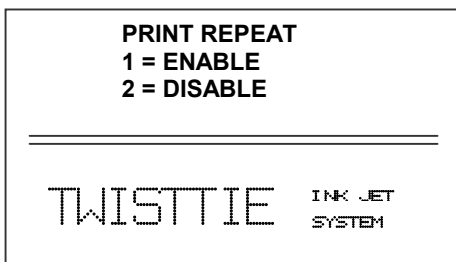

The default Speed Control is the HEAD ENCODER. As such, the print registration and character width is guided by the encoder built in to the print head system. If INTERNAL is selected, the print width is now controlled by changing the width value from 3 to 200. The start printing signal will still be commanded by the internal encoder.

4 - AUTO REPEAT:



This parameter enables the unit to continuously print repeated codes at specified time intervals along the entire length of the twist tie material. Press **1** to enable or **2** to disable print repeat. Activate your choice by pressing **↵**. When you enable the auto repeat parameter, you have to select the time delay needed between codes. After **↵** is pressed, the

screen will change to allow selection of the time delay. Use  or  to change the selection. Each number in the time delay adds or subtracts a distance equivalent to the width of 3 printed dots. Save your choice by pressing .

F3 MENU

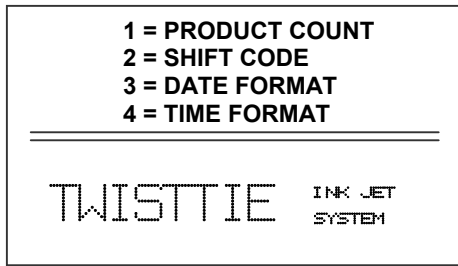

Place the unit in the Command mode and press **F3**. The screen shown to the left is produced. Press the correct number to make changes to that parameter

1 - PRODUCT COUNTER:

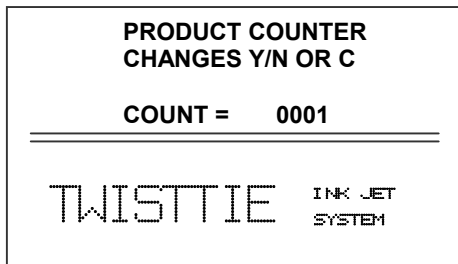

The unit can be programmed to count the number of codes applied to twist tie material during a specific period of time. Pressing **1** generates the screen shown on the left. If the time period over which you need to count product is not correct, press **Y**.

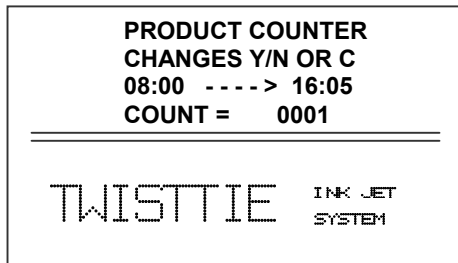

The screen will change and ask for the hour and minutes to start counting and the hour and minutes to stop counting, as shown to the left. After the hours are entered, the screen will change and ask for the minutes. Always include a "0" before single digit numbers like 08 hours for 8 AM, etc. Once all the information is entered that defines that time period you need to count product, the screen

will look as shown to the left. If the period of time for counting is correct, and the counter needs to be reset, press **C**. If the information shown on the screen is correct, press **N** and return to the STOPPED screen, otherwise press **Y** to start the sequence again. This information will not be printed by the TTP system.

NOTE: THIS INFORMATION IS NOT PRINTABLE ON THE TWIST TIE AND MAY ONLY BE ACCESSED WITH THE ABOVE PROCEDURE.

NOTE: The time must be entered in the military time (24 hour) format.

2 - SHIFT CODE:

The unit can be programmed to print either a **two digit** shift code or a **single letter** shift code that automatically increments when a shift ends. The shift time period has a minimum increment of 15 minutes and the total time for all shifts combined can not exceed 24 hours.

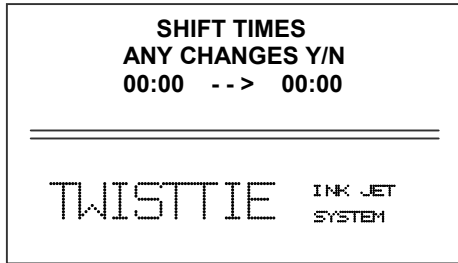

Pressing **2**, starts the sequence and presents the screen shown on the left. To input the start time and the length of the shift, press **Y**.

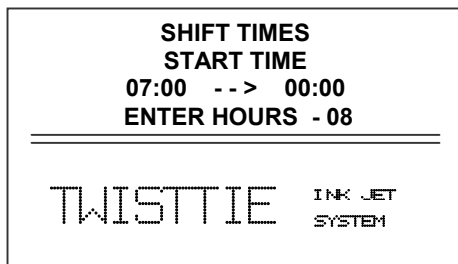

The screen will change and ask for the hour that the shift starts. Enter time using two digits 07. Following this, the screen will change to allow the minutes to be entered.

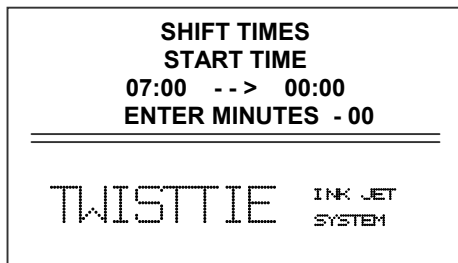

The display shows that we entered the shift start time of 07:00 as a start time

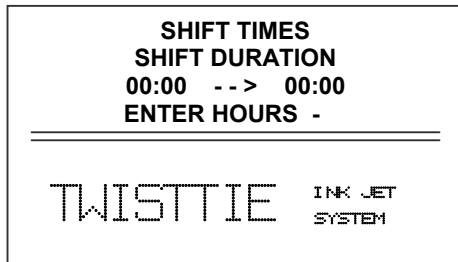

With the shift start time defined, now the duration has to be defined in hours and minutes as shown at the left. Enter the length of time, using two digits, that the shift will last in hours and minutes. Enter 08 for a shift duration of 8 hours..

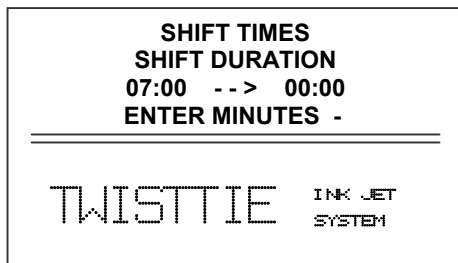

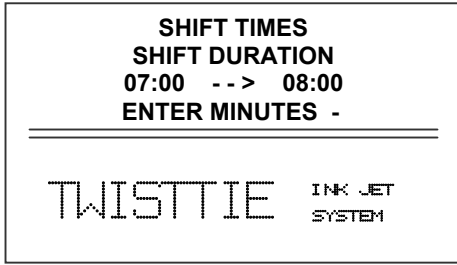

Enter 00 for the minutes of shift duration.



The display shown at the left indicates that the shift time starts a 07:00 in the morning with a shift duration of 08:00

Once the times are correct, press **N** to save the data.

To build this in a message, press  when the cursor is at the location you want to show the shift code. Enter the starting shift character or digit(s) and press ,

The unit does not update this information on the LCD and only shows the initial shift code printed. A test print will show the actual code.

3 - DATE FORMAT:

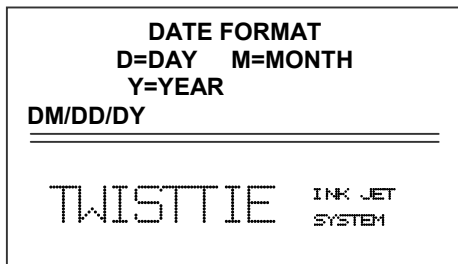
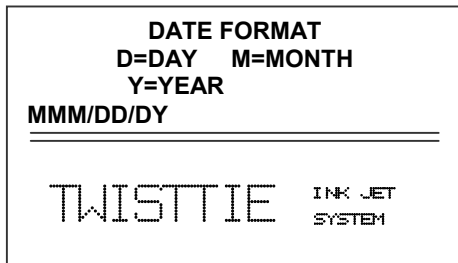
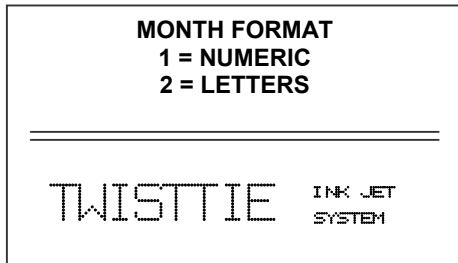

The default format for the date is month/day/year in number form. To change this format, press **3**. The screen at the left is displayed. Press either **1** or **2** to select the desired format for the month and press . As an example, the numeric format is represented by 03 for March and the letters format would be MAR. When this selection is made one of the detailed screens shown below is then displayed. For numeric format: Select 1 For letter format: Select 2 Delete the old format by pressing the pressing followed by pressing the alphabetic keys to create the desired format. Any combination of month, day, year or julian can be programed by pressing the various alphanumeric keys (D, M, Y, J). Remember to include all other characters as part of the format (spaces or slash marks) between the month, day and year. Press to exit. This format will be used each time is pressed when building a message.

4 - TIME FORMAT:

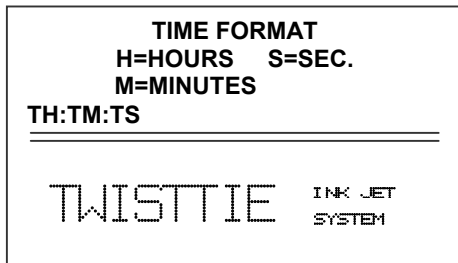

The default format for the time is hours:minutes:seconds. Press **4** to change the format present on the screen shown on the left. Press to delete the existing format. Any combination of hours, minutes, or seconds can be programmed by pressing the various alphanumeric keys (H, M, S). Remember to include all other characters as part of the format (spaces or colons). Once complete, press to return to the Command mode. The format developed here will be inserted whenever is pressed while building a message.

F4 MENU

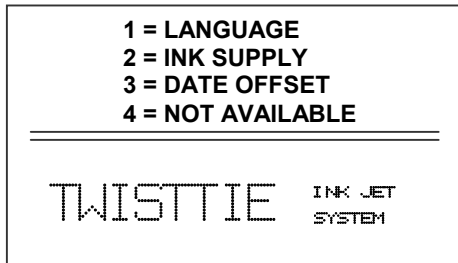

Place the unit in the Command mode and press **F4**. The screen shown at left is produced. Press the number that corresponds to the parameter you wish to change.

1 - LANGUAGE :

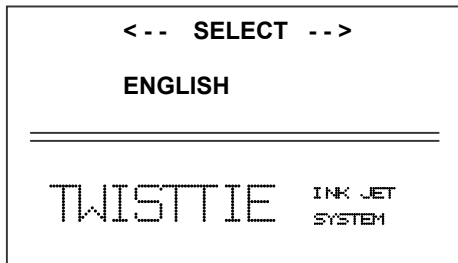

Press **1** and the screen will change like the one on the left. The default language is English; the other choice is Spanish. Scroll through the choices using either **◀** or **▶**. Once the desired language is shown on the screen, press **↩**. This will return the unit to the Command mode. Whenever language is chosen, all prompts and commands

shown on the screen will be in that language.

2 - INK SUPPLY:

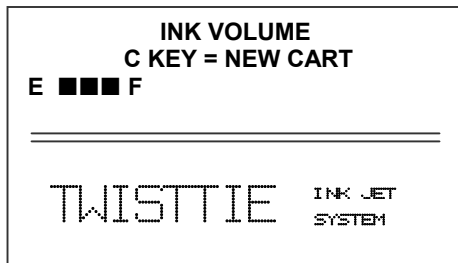

Updating is required whenever a new cartridge of ink is inserted into the unit. This will reset the ink level gauge. Press **2** and the screen will change as shown to the left. Pressing **C** resets the gauge. The screen verifies this reset by quickly showing a confirmation screen. Return to the “Stopped” mode by pressing **↩**

In the event the low ink indicator does not accurately activate when an ink cartridge is empty the system ink calculation needs to be re-calibrated. To perform this task the following procedure must be followed:

Press **F4** **2** **C**. This resets the ink calculator.

Insert a new ink cartridge.

When the new ink cartridge is empty press **F4** **2** **K**. This re-calibrates the ink calculator.

3 - DATE OFFSET:

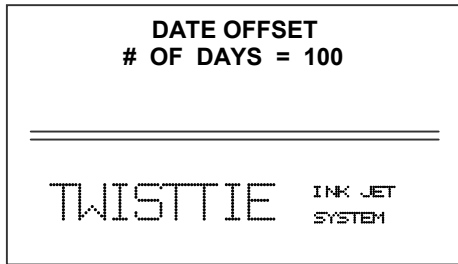

The date offset parameter allows a future date to be coded on the product. This is useful as a “Sell by” code. Press **3** to begin the sequence of steps necessary to set up this feature. The screen on the left will show a default of “100” days. Using the numeric keys, enter the number of days to offset the code. For example, if 150 days are needed,

press 1, 5, 0. The maximum number of offset days is 999. To return to the Command mode, press .

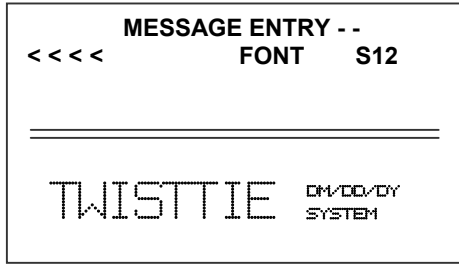

This feature is used when building a message. The above sequence is the first step necessary in setting the number of days to offset. To insert the offset date, you must be in the process of building a message. Position the cursor where the date offset is to be located in the message string and press .

. This screen to the left will result. After the message building is complete, return to the Command mode by pressing . The date offset will remain as shown on the screen above, until the first print is made. At that point, the DM/DD/DY will be changed to a future date representing the number of days offset from the current date as defined.

SETTING UP SYSTEM PARAMETERS

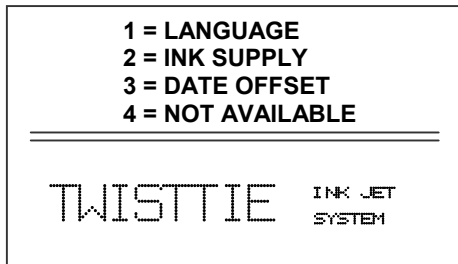

The printer is programmed to default to the English language; however, the user has the option of selecting Spanish. To change the language press.

F4

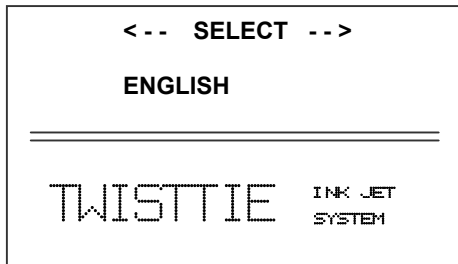

After pressing **F4**, press as indicated on the display. Use **◀** or **▶** to scroll through the language options.

To accept a language, press **↩**. Once pressed, the LCD will return to the default screen in the selected language as shown to the left.

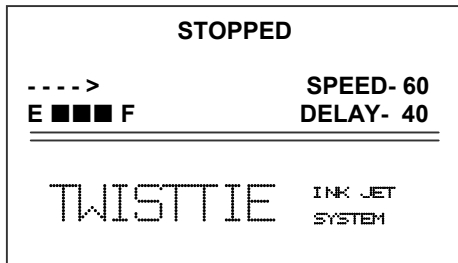



SETTING THE DATE

```
PRESENT SETTING
ANY CHANGES Y/N
01/01/01

-----

TWISTTIE      INK JET
                SYSTEM
```

In order to change the current date in the unit, be sure the unit is in the command mode. Press the STOP PRINT  key. Press . The screen will change to look as shown on the left. If the date shown is correct, press  to accept the values and exit.

```
DATE CHANGE

09/01/03
ENTER MONTH - 09

-----

TWISTTIE      INK JET
                SYSTEM
```

Press  to enter the date starting with the month. For single digit months enter in the zero, as in 09 for September.

```
DATE CHANGE

09/08/03
ENTER DAY - 08

-----

TWISTTIE      INK JET
                SYSTEM
```

Next enter in the day of the month. For single digit days enter in the zero, as in 08 for the 8th.

```
DATE CHANGE

09/01/03
ENTER YEAR - 03

-----



TWISTTIE      INK JET
                SYSTEM
```

Finally, enter in the year. For single digit years enter in the zero, as in 03 for 2003.

```
PRESENT SETTING
ANY CHANGES Y/N
09/08/03

-----

TWISTTIE      INK JET
                SYSTEM
```

The screen redisplay the new date. If the date entered is correct press the  key to return to the STOPPED screen or the  key to re-enter the correct date.

SETTING THE TIME

```
PRESENT SETTING
ANY CHANGES Y/N
10:07:00

TWISTTIE INK JET
SYSTEM
```

```
TIME CHANGE
07:02:00
ENTER HOURS - 07



TWISTTIE INK JET
SYSTEM
```

```
TIME CHANGE
07:02:00
ENTER MINUTES - 09

TWISTTIE INK JET
SYSTEM
```

```
PRESENT SETTING
ANY CHANGES Y/N
07:09:00

TWISTTIE INK JET
SYSTEM
```

In order to change the time in the unit, be sure the unit is in the command mode. Press the STOP PRINT  key. Press . The screen will change to look like the one on the left. If the time shown is correct, press  to accept the values and exit.



Press  to enter the time starting with the hours. For single digit hours enter in the zero, as in 07 for 7 AM.

NOTE: TIME IS ENTERED IN MILITARY TIME FORMAT (24 HOUR CLOCK).

Next enter in the minutes.

For single digit minutes enter in the zero, as in 09 for 9 minutes.

The screen redisplay the new time.

If the time entered is correct press the  key to return to the STOPPED screen or the  key to re-enter the correct time.

SETTING OTHER PARAMETERS

There are two parameters that control how the message will print:

CHARACTER WIDTH – This setting adjusts the width of the printer message on the twist tie material. Depending on the length of the tail on the twist tie the message may require compression to ensure the entire message is readable on the exposed tail of the material.

PRINT DELAY – This setting adjusts the location of the printed message on the tail of the twist tie

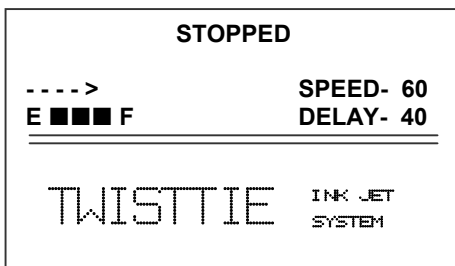



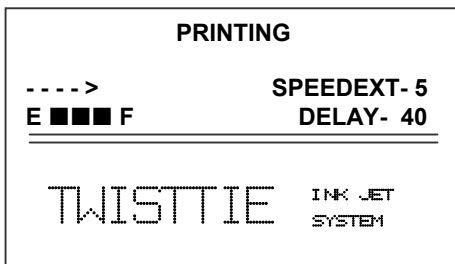

Access to these parameters is possible when the unit is in either the Command or Printing mode as shown to the left.

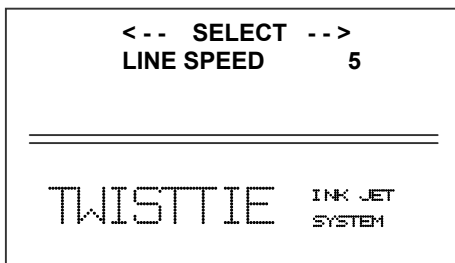

NOTE: When in the command mode the SPEEDEXT message will show SPEED. To change the character width the unit must be in the PRINTING mode

SETTING CHARACTER WIDTH



Normally, the system will be set to use the internal encoder for character width control. The default value is 5, which creates a normal width character. The print can be narrowed by decreasing the number and widened by increasing the number. The unit must be in the PRINTING mode. This parameter is accessed by pressing . Once pressed, a new screen appears, as shown to the left. Changes can now be made by using  or . The range of values for character width is 1 to 9. Once the desired number is chosen, press  to save your entry.

SETTING PRINT DELAY

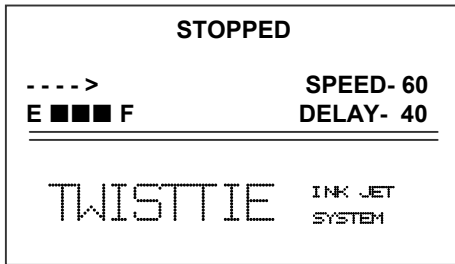

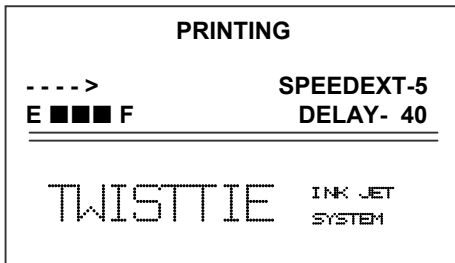

Print delay is used to position a message on the twist tie material at a location other than at the leading edge. Access this parameter by pressing  on the keypad.

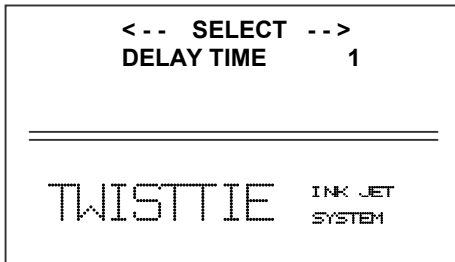

NOTE: This parameter may be set when the unit is either in the PRINTING or STOPPED mode



To change the value use either  or . The range of values for this parameter is 1 to 255. Each increment represents the space that one dot would occupy if it were printed. Therefore, a delay of 255 would approximate the same distance as if 255 dots

were printed. Once a number is chosen, press  to save the entry.

NOTE: Setting the character width first, then adjusting the print delay may prove to be the best starting point

INPUT, EDIT OR DELETE MESSAGES

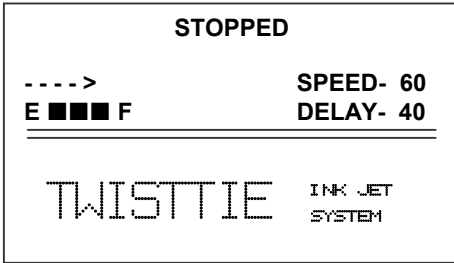

To input, delete or edit a message, the unit must be in the STOPPED Mode. If the LCD reads PRINTING, press . The screen should be similar to the one shown at the left.

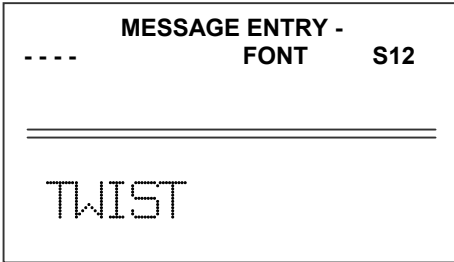

Enter the Message Entry mode by pressing . The top portion of the screen will change as shown on the left. The default font style is S12 (12 x 9 character) for all TTP Models. If a different font is desired, press until the desired font is shown. The font shown is the one used in building the message from this point on.

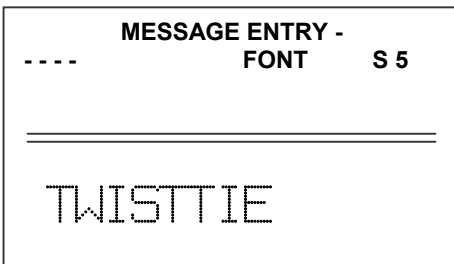

As you continue to build the message, press to change to another font.

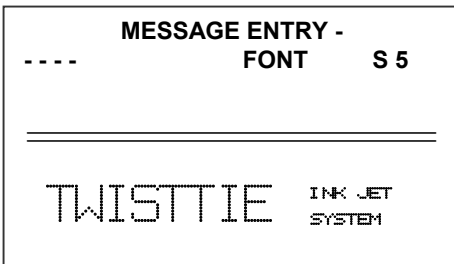

For example, to mix S12 with S5 (5 x 5 character) font, the message would look as shown left. Press until the S5 font is shown.

The message shown to the left would be an example if the S5 font were used after the S12 font. To place the second S5 font line use the to position the cursor to the second line and press the to activate the S5 font. To delete a message shown on any line, press or to position the cursor at the beginning of the line for deletion. Press to erase the entire message on that line and begin building the correct message.

NOTE: When the S12 font is used in combination with any other font the entire message is deleted

Once the message line(s) is complete, save the change by pressing .

If date, time, or date offset, are to be included in the message, position the cursor at the desired location and press either for the date or for the time or for the date offset.

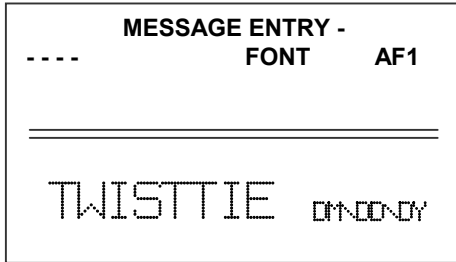

Another example using the AF1 font (7 x 5 Bold) font size. Use the until the AF1 font is selected and enter the date in the lower message line shown by pressing the , this will produce a screen as shown at the left. Notice the date was placed in the second line and the font used was AF1. The

“DM/DD/DY” remains as shown until the first print is made. At that point, the screen changes to the actual date, time or date offset. You may have a combination of up to 32 spaces or characters in the message line.

NOTE: If the date or time is not inserted in the message line after pressing the date and/or time key, these parameters need to be formatted. Press to return to the Command mode, followed by for date and time and for date offset . Then press the appropriate numeric key. These will not be inserted if the message, plus the spaces needed for date or time exceeds 32 characters or spaces. Make sure the total number of characters or spaces do not exceed 32.

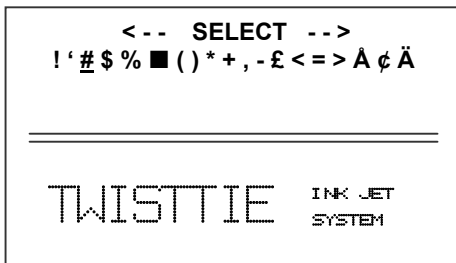

Symbols are inserted by pressing . When in Message Entry mode, position the cursor where a symbol is needed and press . The screen will show a line of symbols as presented on the left. Position the cursor by pressing or to the left of the special character to be inserted and press .

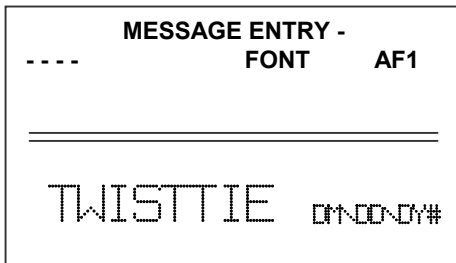

NOTE: As the cursor is moved to the right additional characters are displayed. In this example, the # sign was added to the end of the message.

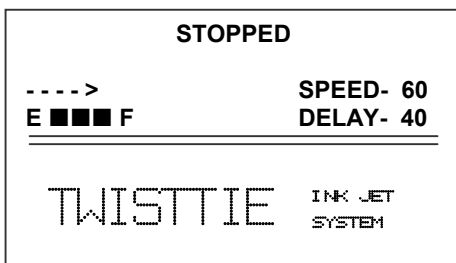

Continue to build the message or press to return to the Command mode.

PASSWORD PROTECTION

PASSWORD XXXX
=====
=====

The TTP product contains a password function designed to limit access to the edit menu and prevent unauthorized changing of message lines. To activate this function, switch the unit off, then press and hold **P** while switching the unit on. The display changes and requests the default password (which is 1234). Enter the 1234.

ENABLE PASSWORD YES OR NO Y/N
=====
=====











The screen to the left appears and prompts the operator or **ENABLE PASSWORD**
A response of N maintains the current password and disables password protection.

PASSWORD XXXX
=====
=====

If the response Y is selected the screen at the left appears to prompt the user to enter a new password. Enter the new 4 character password any combination of letters and numbers may be used. Once this has been completed, the unit will not allow message editing without the entry of the password.

If the new password is misplaced or forgotten, reset the unit by turning off the power and while pressing and holding **R turn on power to the unit. This will reset the password to the default of 1234.**

EDITING THE MESSAGE OR PARTS OF A MESSAGE

If the message contains large (S12 and B12) and small characters (S5 and S7), the only way to edit the message is to erase the entire message and enter the new message. To enter Message Entry / Edit by pressing  (be sure the unit is in the Command mode). All message lines may be erased by pressing . To erase any line, NOT CONTAINING S12 OR B12 FONTS, press the necessary  or  to position the cursor at that line. Press  to move the cursor to end of the line and press  to erase the entire line. To erase only a portion of the line, use  or  to position the cursor at the end and press  for the characters needing to be erase. Once any line or part of any line is erased, a new message may be started by pressing the necessary keys. In the event an error is made when building a new message, corrections can be made by pressing the . For example:

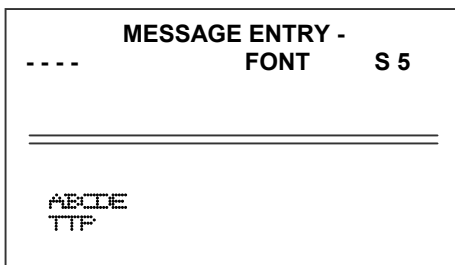



The top line shows “ABCDE”. To remove the “DE” from this line, position the cursor at the end of the line and press  twice. Each time this key is pressed, the cursor moves to the left one space and erases a character.



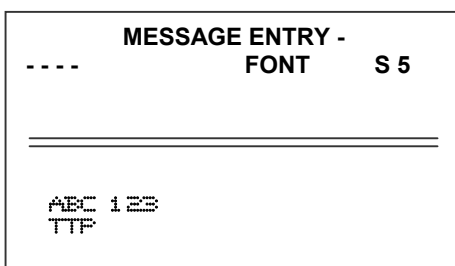

The display at the left shows the results (“D and E” have been erased).

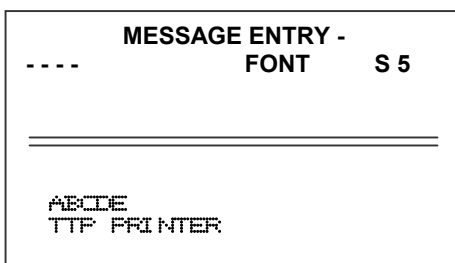

Once erased, any new character may be inserted, as shown to the left with the addition of a “SPACE” and “123”.

If, only part of an existing line needs change, press the  or  to move the cursor to a character needing change and overwrite it by pressing the appropriate key.



The new character will carry the same parameters as the one replaced. This is shown at the left as the word “TTP” to “TTP PRINTER” the message lines are displayed correctly, press  to save all changes and return to the Command mode.

STORING A MESSAGE

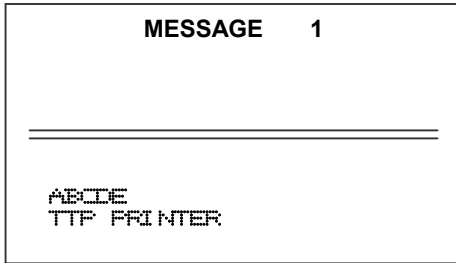

All TTP units are able to store up to 25 programmed messages and the parameters. Follow these steps to store a message. Create the message and press . Press . Using or , scroll to the desired message location number and press a second time. This places the message into that numeric location for recall at a later time. Use the same procedure to overwrite an existing stored message as well. Press to exit.

NOTE: Message storage is intended to be used after twist tie material has been coded satisfactorily. When a message is stored all operating parameters of the printed code are saved. Once recalled, codes will be printed the same as they had been before.

RECALLING A STORED MESSAGE

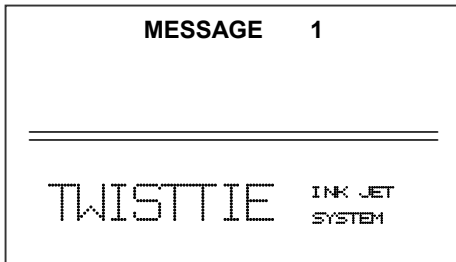

Place the unit in “Stopped” mode and press . Use the or to scroll through the stored messages. Find the desired message and press . That message is now displayed on the screen ready for printing.

PART 3 : MAINTENANCE PROCEDURES

CONTENTS

Short Periods of Shut-down	3-2
Long Periods of Shut-down	3-3
Print Cartridge Maintenance	3-4
Print Carriage Maintenance	3-5
Exploded View of C20812 Print Carriage	3-6

SHORT PERIODS OF SHUT-DOWN

When the printer has been shut down overnight, the system might require a purge to clear out dust particles that have settled on the nozzle area during non-use. This is only necessary if there are missing dots in the printed code on the twist tie material.

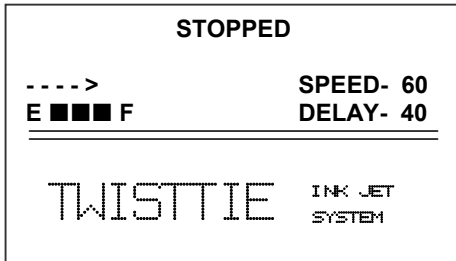

To purge be sure that the unit is in the STOPPED Mode by pressing green  key. The screen changes to STOPPED as shown to left.

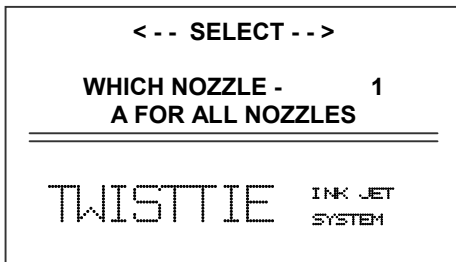

Slide a piece of lint free wipe (or absorbant paper) in front of the print head and press the red  Each nozzle may be individually selected by pressing the corresponding number (number 1 is the top nozzle) or press **A** for all nozzles. Allow the unit to purge for several seconds. There is an automatic shut down after 5 seconds to ensure that the print head will not be damaged. Press any key to stop purging.

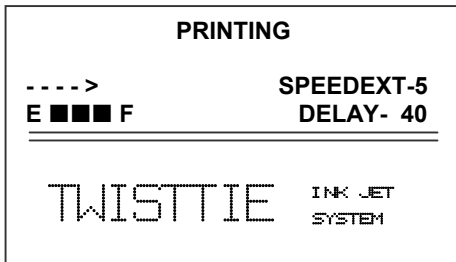

If ink residue has solidified on the nozzle area a small drop of water may be applied to the lint free wipe.

Press the green  and the screen changes to PRINTING, as shown at the left. The unit is ready to begin coding.

LONG PERIODS OF SHUT-DOWN

When the printer is to be shut down for extended periods, or the ink cartridge needs to be changed to insert a different color cartridge, the ink cartridge should be removed.

Clean the print head nozzle area with a soft, lint free wipe and insure there is no ink residue remaining on the nozzle area. Re-apply the sealing tape (originally supplied with the print head) to completely cover the nozzle area.

CAUTION: USE ONLY THE ORIGINAL SEALING TAPE SUPPLIED WITH THE TTP INK CARTRIDGE. DO NOT USE ANY OTHER MATERIAL OR ANY ADHESIVE BACKED PRODUCT AS THIS WILL DAMAGE THE NOZZLE AREA.

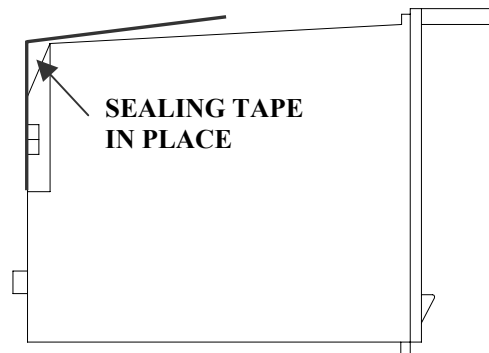

PRINT CARTRIDGE MAINTENANCE

It is necessary to maintain the TTP ink jet cartridge free from accumulated dust and debris. Periodically the TTP ink cartridge should be removed and cleaned. This is totally dependent on the operating environment and the average printable life of the ink cartridge. In extremely dusty environments, this maintenance procedure may be required daily but on average every 2 to 3 days should be sufficient.

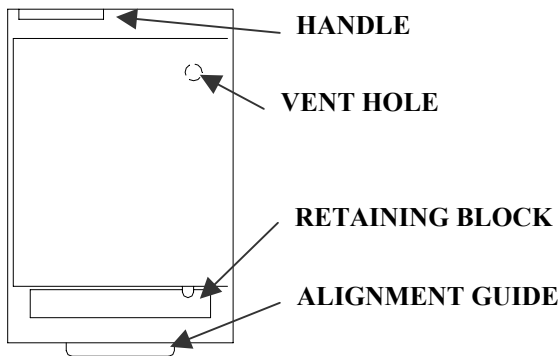
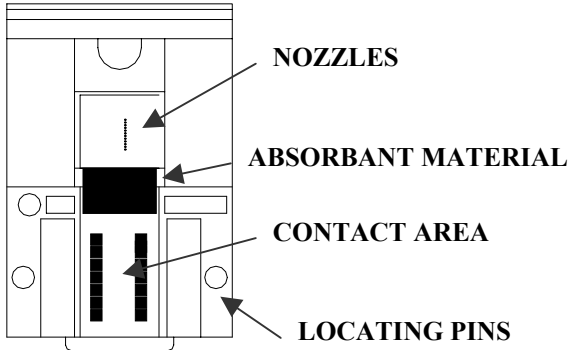

To clean the cartridge, remove it from the print carriage and carefully clean the face of the cartridge with a soft, lint free wipe. Use caution in wiping the **NOZZLE** area so as not to scratch the face.

Clean the **CONTACT** area in a similar fashion.

Inspect and re-insert the ink cartridge into the TTP head carriage following the procedure for **INSTALLING THE INK CARTRIDGE**.

PRINT CARRIAGE MAINTENANCE

It is necessary to maintain the TTP print head carriage free from accumulated dust and debris. Periodically the print head carriage should be inspected and cleaned. This is totally dependent on the operating environment. In extremely dusty environments, this maintenance procedure may be required daily but on average every 2 to 3 days should be sufficient.

Remove the TTP ink cartridge and carefully inspect the print carriage C20812 for dust and debris. Since the TTP printer must print on twist tie material that is either paper/plastic or paper/paper, there will normally be a build up of paper debris in the print head carriage assembly.

Using a dry compressed air source remove any dust residue from the assembly, paying particular attention to the TOP BEARING, PRESSURE ROLLERS and PRESSURE ARM.

Test the PRESSURE ARM several times by pulling the arm away from the PRESSURE ROLLERS to ensure it does not bind in either direction. It is spring-loaded and will return to apply tension against the PRESSURE ROLLERS.

Using a piece of twist tie material between the PRESSURE ARM and PRESSURE ROLLERS ensure that as the twist tie material is moved to the left and right, that the PRESSURE ROLLERS move freely.

Re-insert the TTP ink cartridge and place the unit into the PRINTING mode by pressing .

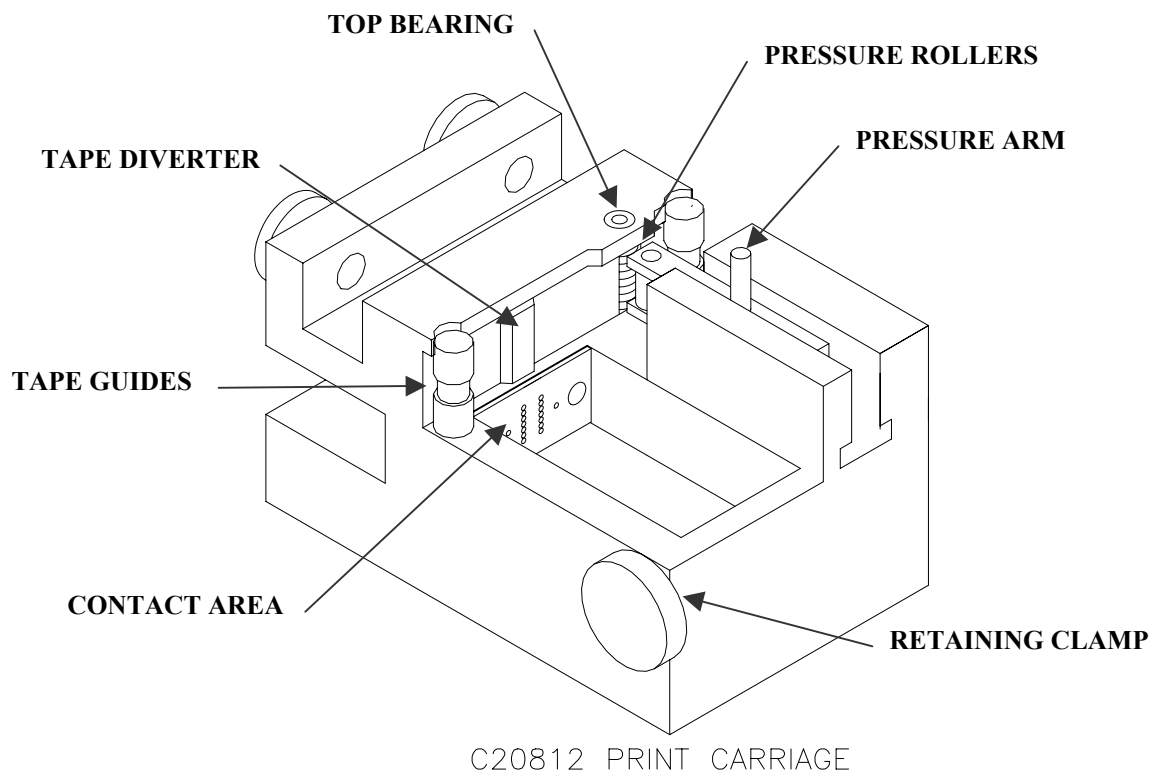

EXPLODED VIEW OF THE C20812 TTP PRINT CARRIAGE

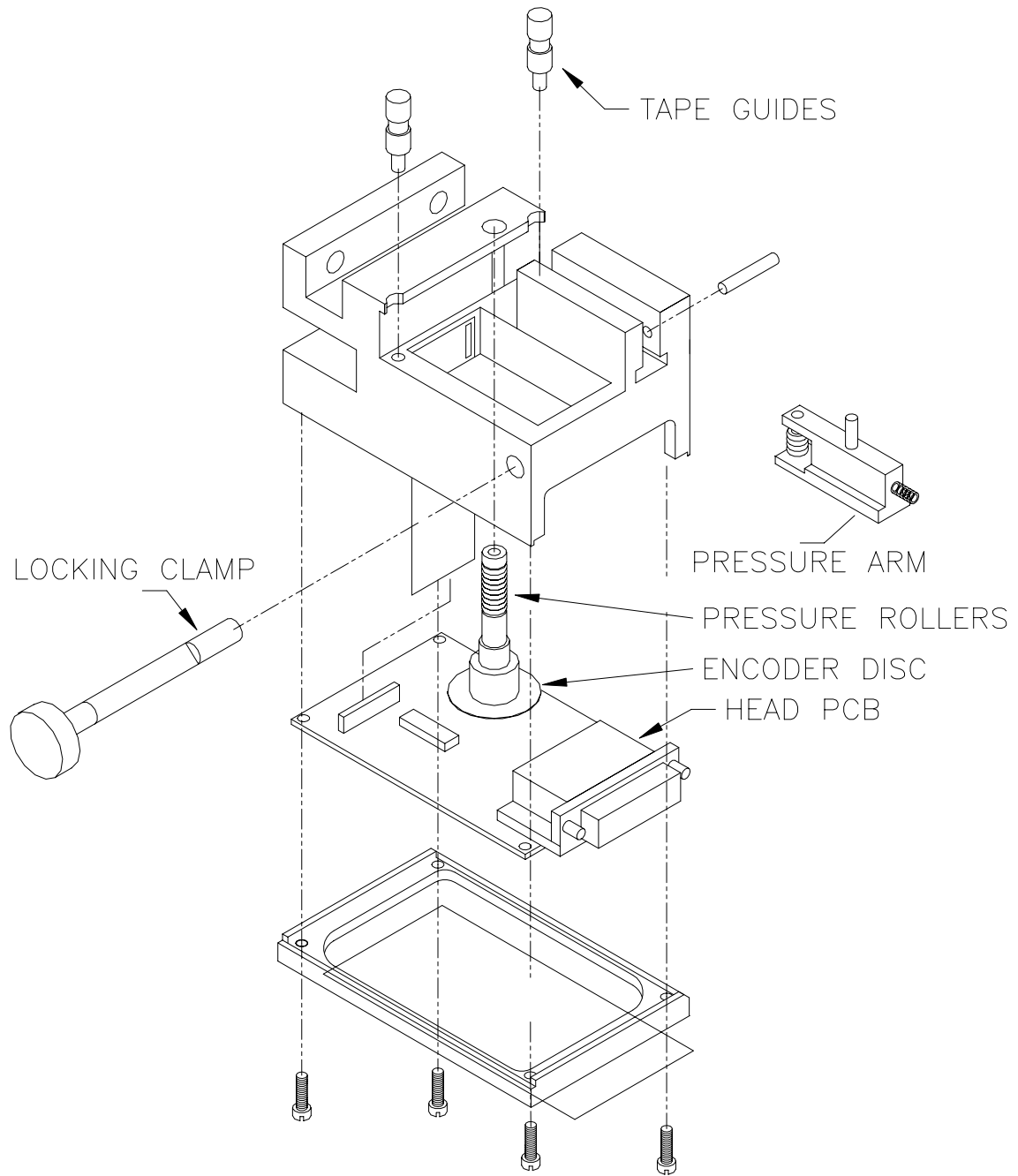





PART 4 : TROUBLESHOOTING AND REPAIRS



CONTENTS

FAULTS	4-2
LCD remains blank	4-2
Unit does not print, although LCD shows information	4-2
Message entry will not accept a date or time code	4-3
Shift code on LCD does not increment	4-2
Low ink indicator on with full ink cartridge	4-3
Unit does not purge	4-3
A nozzle emits a solid stream or leaks ink	4-3
Missing one or more dots from code.	4-3
Unit loses data while printing	4-3
Print does not adhere to twist tie material	4-3

FAULTS

This chart was created to assist the user in troubleshooting the unit. Find the problem in the first column; apply the remedy(s) suggested in the third column.

Condition	Probable Cause	Remedy
LCD remains blank.	No power.	Ensure power connector is plugged into the correct power source
		Check correct voltage settings and power switch in the ON position
Unit does not print, although LCD shows information.	Encoding device not operational	Check that the encoder wheel turns when material is moved. If not, call for Technical Service.
	No message in unit	Input your message (see pages 2-18).
	Unit in "COMMAND" mode.	Press  .
	No ink.	Replace ink cartridge; reset ink volume parameter (press  and follow the sequence.
Message entry will not accept a date or time code.	Date and/or time is not formatted.	Set date and/or time format. Press  , followed by either  or  . See page 2-11
Shift code on LCD does not increment.	None	Shift code "count" is seen only in the output, not on the LCD.

Condition	Probable Cause	Remedy
Low ink indicator on with full ink cartridge.	Did not reset ink volume parameter.	Press <input type="button" value="F4"/> . Continue key entry following menu prompts.
Ink Cartridge empties before low ink indicator on	System needs calibration	See page 2-21.
Unit does not purge.	Out of ink.	Replace with full ink cartridge. Reset ink volume parameter (press <input type="button" value="F4"/>).
	Unit in "PRINTING" mode	Press Stop Print. 
	Ink cartridge clogged	Clean Ink Cartridge Nozzle area with lint free wipe
Missing one or more dots from code.	No ink.	Clean or Replace cartridge and purge system (press ).
	Long down-time.	Follow daily start-up procedure if your line experienced a long down time.
Unit loses data while printing	Static electricity	Eliminate source of static. Attach ground strap between print head and low impedance earth ground.
	High levels of radio frequency.	Move unit to an alternate location or attach ground strap as above.
	Spikes in electrical line.	Use AC line filter to guard against line spikes.
Ink does not adhere to the twist tie material	Printing on the plastic side of the twist tie	Re-orient material such that the paper side faces the print head

PART 5 : PARTS LIST

Part No.	Description
C20980	TTP Controller Assembly
C20814	PLAS-TIES Model 603 Mounting Bracket
C20814	PLAS-TIES Model 604 Mounting Bracket
C20812	Print Head Carriage Assembly
C40016-3	Print Head Cable 3 Feet
C20680	LCD Assembly
*****	TTP Microprocessor
4052BK	4 Pack of Black Ink Cartridges
4052RD	4 Pack of Red Ink Cartridges
4052GR	4 Pack of Green Ink Cartridges
4052BL	4 Pack of Blue Ink Cartridges
94089-01	Optional Controller Holder